

American Series

Double Bowl Sink



SPECIFICATION SHEET - 33 x 19 x 8



Model # 398-413

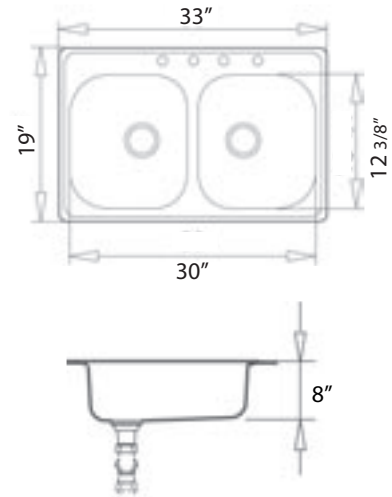

FEATURES:

- Clips - Stainless steel swivel clips for ease of installation
- Large sound deadening pad for superior noise reduction
- High-lustre finish
- One piece - single draw construction. Eliminating bowl and rail weld marks
- Rolled edges and formed rails adding rigidity to outside perimeter
- Steel composition - Type 304 steel 18-10 chrome/nickel content
- 3 1/2" drain opening
- Limited lifetime warranty
- Available in 3 or 4 hole

MODEL#	FINISH	OVERALL DIMENSION	BOWL DIMENSIONS LENGTH WIDTH	SINK DEPTH	CUTOUT DIMENSION	GAUGE
398-413*	Polished	33" x 19"	12 3/8" x 12 3/8"	8	32 1/4" x 18 1/4"	20

* Available in box, sleeved, or bulk packaging

TEKA USA • 4920 West Cypress Street, Suite 106 • Tampa, Florida 33607 USA

Toll Free 800-419-9344 • Phone: 813-288-8820 Fax: 813-288-8604

www.tekausa.com